

PHILIPS Service

RADIO

B4X06T/00R/00K

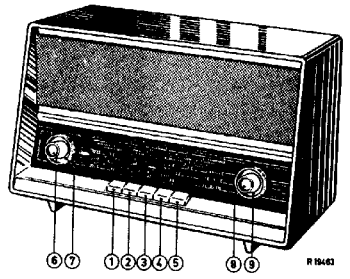

Controls	Bediening	Bedienung	Commande	Organos de mando
P.U. switch	1 P.U. schakelaar	P.U. Schalter	Comm. de P.U.	1 Comm. de P.U.
M.W. switch	2 M.G. schakelaar	M.W. Schalter	Comm. de P.O.	2 Comm. de O.N.
S.W. 3 switch	3 K.G. 3 schakelaar	K.W. 3 Schalter	Comm. de O.C. 3	3 Comm. de O.C. 3
S.W.2b switch	4 K.G.2b schakelaar	K.W.2b Schalter	Comm. de O.C.2b	4 Comm. de O.C.2b
S.W.2a switch	5 K.G.2a schakelaar	K.W.2a Schalter	Comm. de O.C.2a	5 Comm. de O.C.2a
Volume control	6 Volume regelaar	Lautstärkereglér	Rég. de d'intensité	6 Control de volumen
Battery switch	7 Batterijschakelaar	Batterieschalter	Comm. de batterie	7 Comm. de batería
Switch dial lamp	8 Schak. schaalampje	Schalter Skalenlampe	Comm. lampe de cadran	8 Comm. lamparita de escala
Tone control	9 Toonregelaar	Tonregler	Rég. de tonalité	9 Reg. de tono
Tuning		Abstimmung	Syntonisation	9 Sintonía

Specification	Specificatie	Spezifikation	Specification	Especificación		
Loudspeaker	AD 3460 Z	Luidspreker	Leutsprecher	Haut-parleur	AD 3460 Z	Altavoz
I.F.	452 kc/s	M.F.	Z.F.	M.F.	452 kc/s	F.I.
Battery	6x1.5 V	Batterij	Batterie	Batterie	6x1.5 V	Batería
Consumption	14-17 mA	Verbruik	Verbrauch	Consumation	14-17 mA	Consumo
Output	300 mW	Uitgangsvermogen	Ausgangsleistung	Puissance	300 mW	Potencia de salida
Dimensions	345x218x179mm 13 1/2 x 8 1/2 x 7"	Afmetingen	Abmessungen	Dimensions	345x218x179 mm 13 1/2 x 8 1/2 x 7"	Dimensiones

Wave ranges - Golfbereiken - Wellenbereiche - Gammes d'ondes - Mergenes de ondas	Transistors
M.W. - M.G. - M.W. - P.O. - O.N. : 185 - 580 m (1622 - 517 kc/s)	TS1 : 0C170 TS5 : 0C71
S.W.3 - K.G.3 - K.W.3 - O.C.3 - O.C.3 : 75 - 185 m (4 - 1.62Mc/s)	TS2 : 0C45 TS6) : 2-0C72
S.W.2b - K.G.2b - K.W.2b - O.C.2b - O.C.2b : 31 - 64 m (9.8 - 4.7 Mc/s)	TS3 : 0C45 TS7)
S.W.2a - K.G.2a - K.W.2a - O.C.2a - O.C.2a : 13 - 26 m (21.8 - 11.6Mc/s)	TS4 : 0C71 X1-X2: 0A85
	L1 : 8073 D/71

P.S.

In de documentatie van de B4X01T werd per abuis het codenummer van de sierstrip "ALL TRANSISTOR"- "PHILIPS" niet opgenomen. Ook bij de B4X06T werd dit niet vermeld, alsmede de codenummers van de achterwanden. Bedoelde codenummers zijn voor de sierstrip : A3 542 78 en voor de achterwanden respectievelijk : A3 762 56 (grijs) en P4 382 41/801/BJ (zwart).

Bij bovengenoemde apparaten kan het voorkomen dat de achterwandschroeven dol draaien.
Om dit te voorkomen is de achterwandschroef gewijzigd.
Bij het nieuwe type is een moeknok aangebracht.
Het codenummer blijft ongewijzigd nl. A3 715 20.

SERVICE INFORMATION																			
---------------------	--	--	--	--	--	--	--	--	--	--	--	--	--	--	--	--	--	--	--

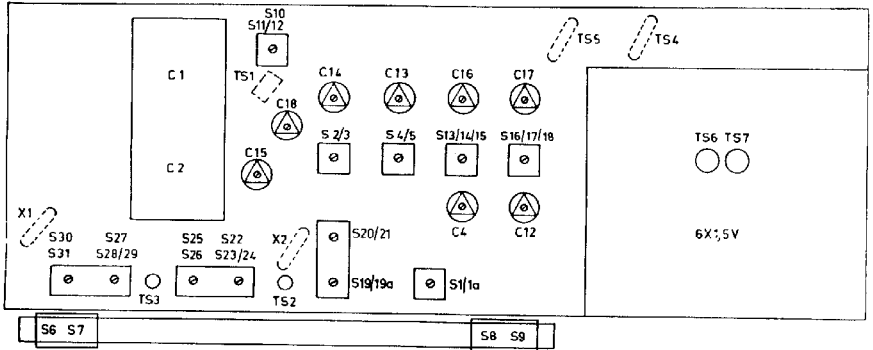

R192 27

I.F. circuits - M.F. kringen - Z.F. Kreise - Circuits M.F. - Circuitos de F.I.

Push button Druktoets Drucktaste Touche pousseiro Pulsador	Trimming point Triempunt Triempunkt Point de réglage Punto de ajuste	Signal Signal Signal Signal Señal	Damp with Compen met Dämpfen mit Amortir avec Amortiguense con	Adjust for max. Afrégelen op max. Abgleichen auf Max. Régler au max. Ajustetense al máx.
5	1600 kc/s	452 kc/s via 100 kn collector TS1	22 kn	S30 - 31 S27 - 28 - 29
				S25 - 26
				S22 - 23 - 24
				S25 - 26
				S19 - 19a S20 - 21
		452 kc/s -		S1 - 1a <u>min.</u>

H.F. circuit - H.F.kringen - H.F. Kreise - Circuits H.F. - Circuitos de H.F.

The signals are applied by means of a couple winding.
Die signalen worden door middel van een koppelwikkelling toegevoerd.
Die Signale werden mittels einer Kopplungswicklung zugeführt.
Les signaux sont appliqués au moyen d'un enroulement de couplage.
Las senales se aplican por medio de un arrollamiento de acople.

Push button Druktoets Drucktaste Touche pousseiro Pulsador	Trimming point Triempunt Triempunkt Point de réglage Punto de ajuste	Signal Signal Signal Signal Señal	Adjust for max. Afrégelen op max. Abgleichen auf Max. Régler au max. Ajustetense al máx.
2	550 kc/s	550 kc/s	S16 - 17 - 18 S8 - 9
	1500 kc/s	1500 kc/s	C17 - 12
Repeat - Herhalen - Wiederholen - Répéter - Repetirse			
3	550 kc/s	1.68 Mc/s	S13 - 14 - 15 S6 - 7
	1500 kc/s	5.0 Mc/s	C16 - 4
Repeat - Herhalen - Wiederholen - Répéter - Repetirse			
5	550 kc/s	11.8 Mc/s	S10 - 11 - 12 S2 - 3
	1500 kc/s	21.5 Mc/s	C18 - 14
Repeat - Herhalen - Wiederholen - Répéter - Repetirse			
4	Tune receiver Ontvanger afstemmen Empfänger abstimmen Accorder le récepteur Sintonicee el receptor	4.75 Mc/s	S4 - 5
	1500 kc/s	9.5 Mc/s	C15 - 13
Repeat - Herhalen - Wiederholen - Répéter - Repetirse			

S	38	1a 1	2 4 6 8 3 5 7 9.					10. 11. 12. 13. 14. 15. 16. 17. 18.	19. 20. 21.		22. 23. 24. 25. 26.		27. 28. 29. 30. 31.		
C	5 6 8		50. 9. 1. 13. 7. 4. 12. 3. 11.	1.	2	15.		21. 18. 16. 17. 19. 20.	22. 10.	25.	23.	24. 28. 44. 26.	27. 29.	30. 31. 33.	34.
R			3.	2.	4.		13. 6.		5.			1. 8. 7. 9.	11. 42. 12.	14. 15.	16. 19. 17. 18.

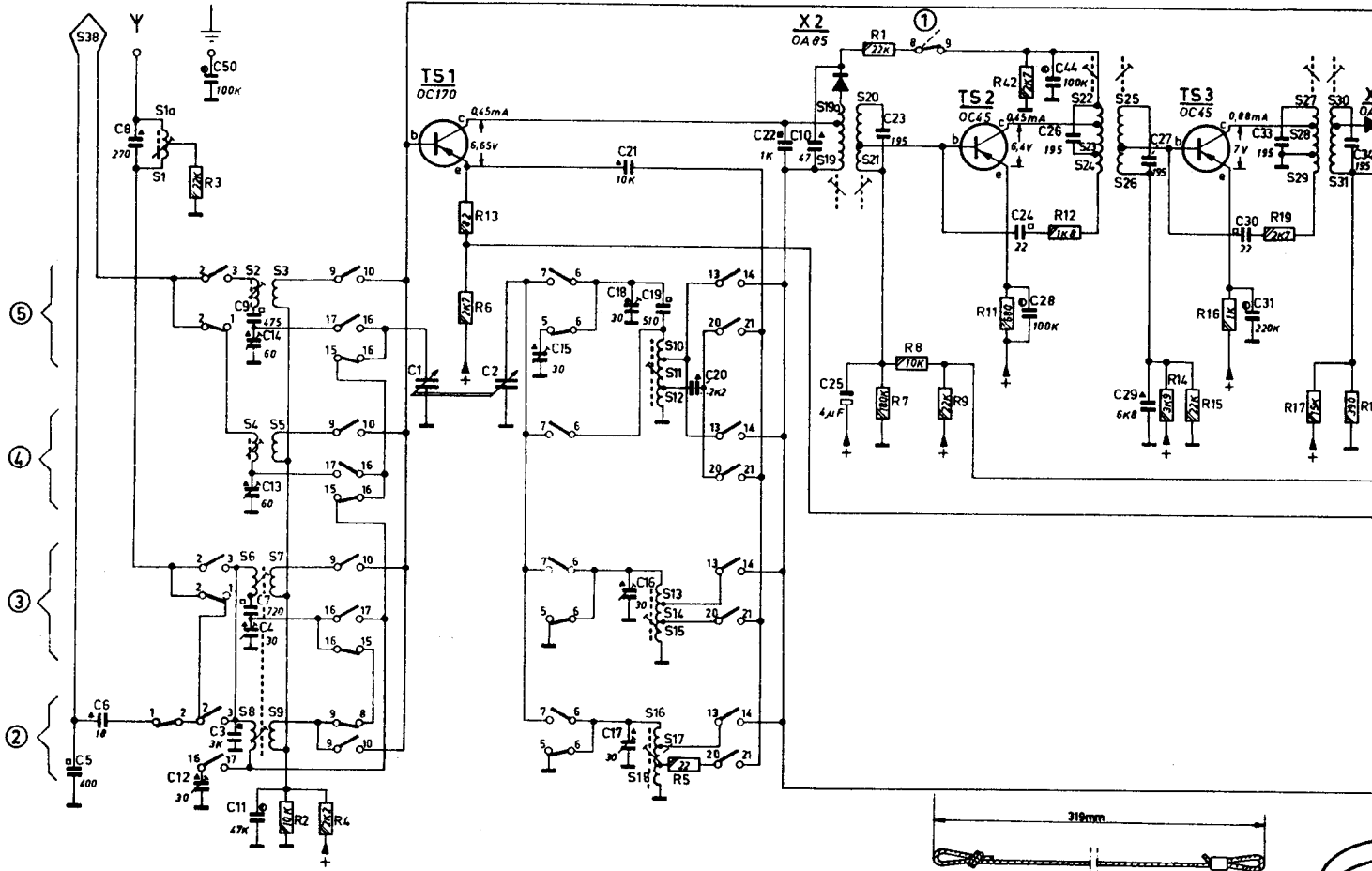

⑤
④
③
②

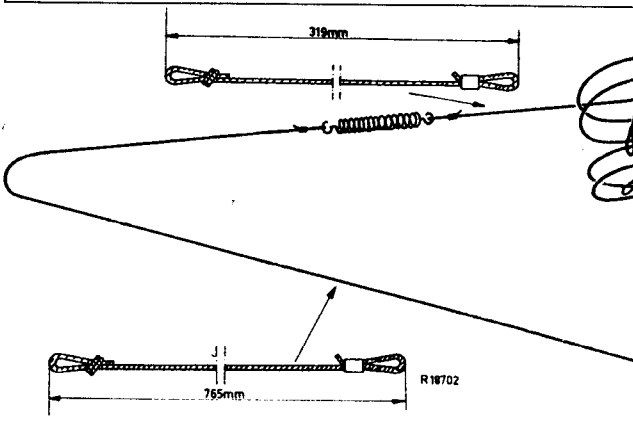
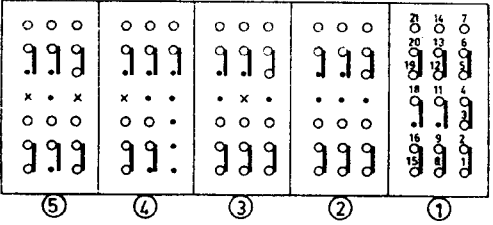

S	37	35 36	34 33 32		F	E A	8			
C	41	36 43	42	49 39 37	38	46 40 47 48	3	8. 50. 7	25 19	
R	32 38	29 39 22	30 21 20 37	36 24	25 33 26	31 34 23 45	28 35 10 44 46	47 43	5 3 9	2. 7. 8.

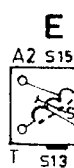
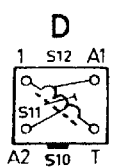
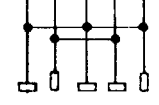
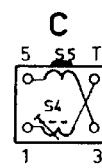
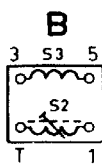
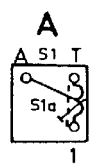
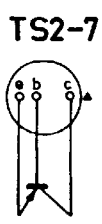
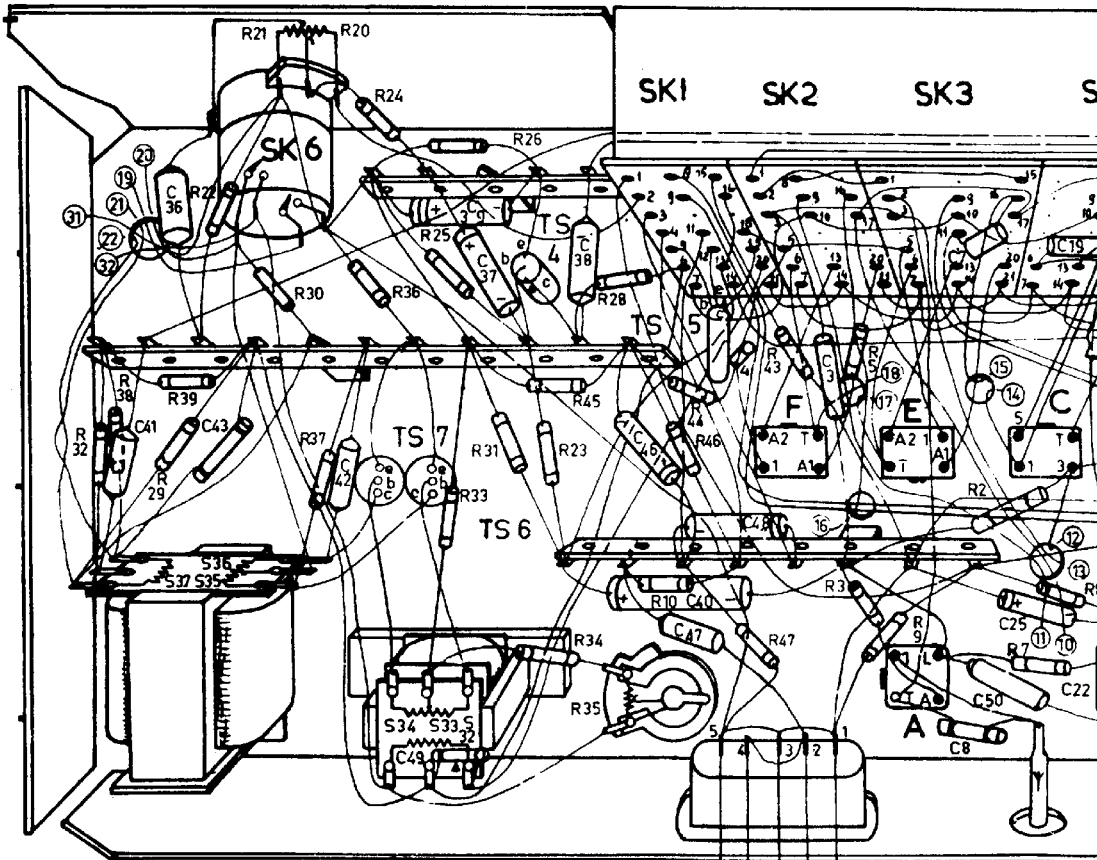

E			B G			D 38 H			J								
25	19	22	9	21	20	24	11	44	28	6	5	29	30	32	45	31	35
8.			1			4 13 12			11 42 6 15 14			16 27 19 18			17 41		

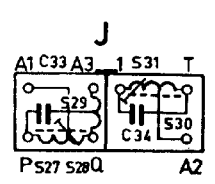
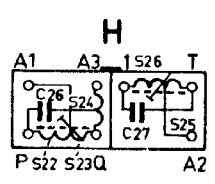
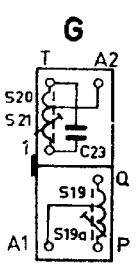
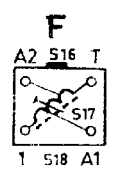
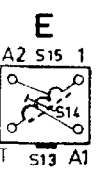
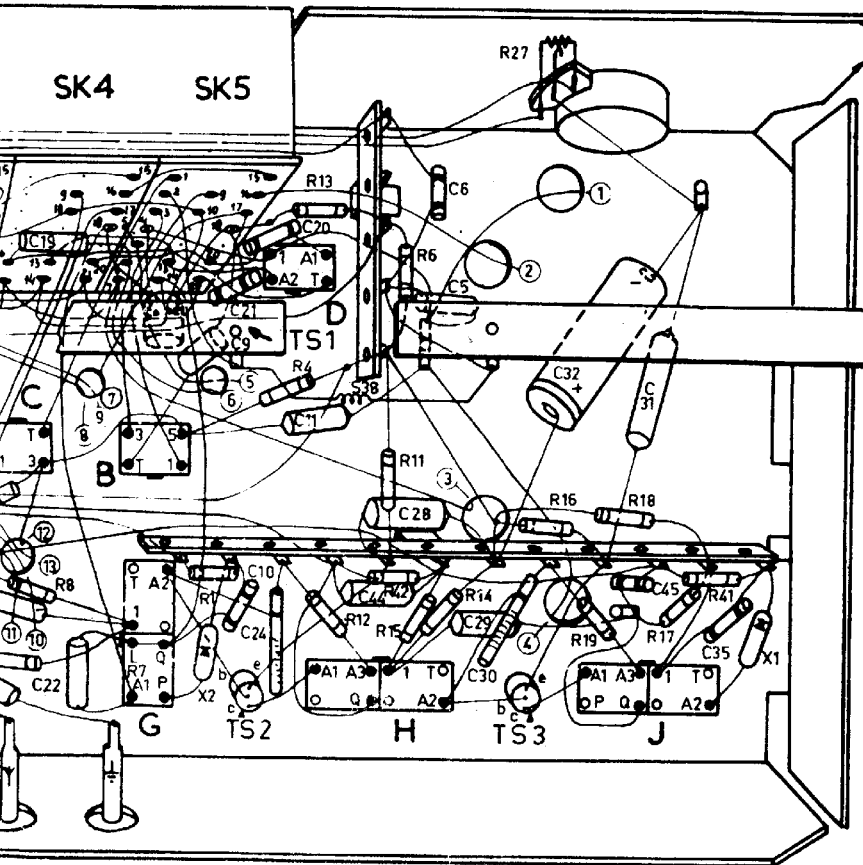

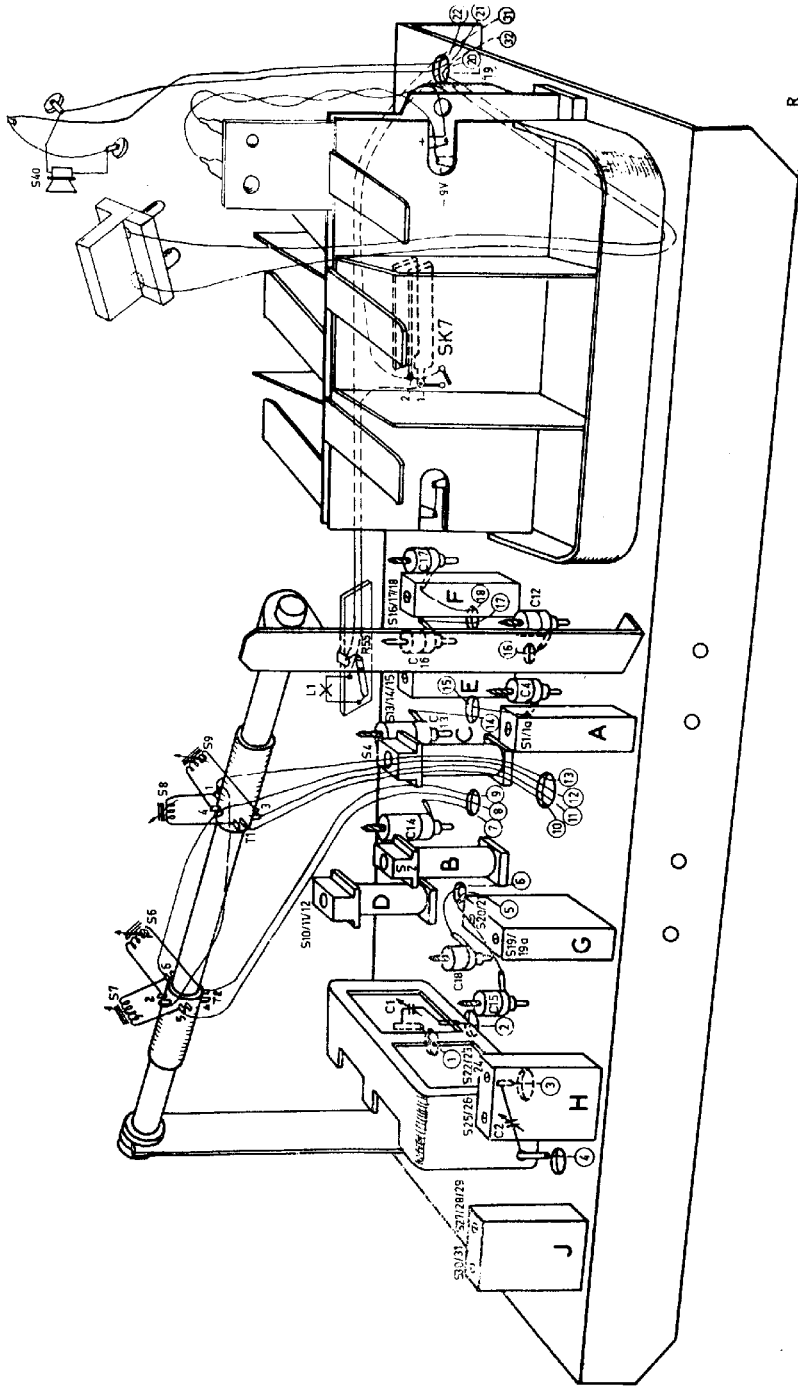

R

R 192 23

<p>Cabinet OOR Cabinet OOK Front</p>	<p>A3 961 30 A3 960 92 A3 686 84</p>	<p>Kaas OOR Kaas OOK Front</p>	<p>Gehäuse OOR Gehäuse OOK Front</p>	<p>Coffret OOR Coffret OOK Front</p>	<p>A3 961 30 A3 960 92 A3 686 84</p>	<p>Mueble OOR Mueble OOK Fronte</p>
<p>Knob 7 + 9 Knob 6 + 8 Bracket, fix rear cover Screw, " " "</p>	<p>P4 077 99/417/UX A3 784 31 A3 773 27 A3 715 20</p>	<p>Knop 7 + 9 Knop 6 + 8 Bügel, Bef. achterwand Schroef " " "</p>	<p>Knopf 7 + 9 Knopf 6 + 8 Bügel, Bef. Rückwand Schraube " " "</p>	<p>Bouton 7 + 9 Bouton 6 + 8 Equerre, fix. panneau Vis, " " "</p>	<p>74 077 99/417/UX A3 784 31 A3 773 27 A3 715 20</p>	<p>Borçón 7 + 9 Borçón 6 + 8 Abracadere, para panel Tornillo, " " "</p>
<p>Battery holder Box for batt. holder Pencil holder Spring P.U. plate</p>	<p>A3 788 45 A3 748 03 A3 788 77 A3 647 73</p>	<p>Batterijhouder Doos, voor batt. houder Contrapring, P.U. Veer, P.U. plaat</p>	<p>Batteriehalter Gehäuse, Batteriehälter Contrastecker P.U. Feder, P.U. Platte</p>	<p>Boîte-pile Boîte porte pile Fiche femelle Resort, plaquette de P.U.</p>	<p>A3 788 45 A3 748 03 A3 788 77 A3 647 73</p>	<p>Porta-pila Caja, porta-pila Clavija, hembra P.U. Resorte, placa de P.U.</p>
<p>Contact slide Contact plate Slide contact Contact lip</p>	<p>971/109 971/110 971/77 971/79</p>	<p>Contactschuif Contactplaat Schuifcontact Contactlip</p>	<p>Kontaktschiebe Kontaktplatte Kontaktkontakt Liprinne</p>	<p>Tiroir Plaquette fixe Contact pour tiroir Contact pour plaquette</p>	<p>971/109 971/110 971/77 971/79</p>	<p>Placa deslizante Placa porta contactos Contacto deslizante Contacto fijo</p>
<p>Push button Dial (O.V.) Dial (S)</p>	<p>P5 420 32/139/F.C. A3 939 87 A3 539 88</p>	<p>Druktoets Skala (O.V.) Skala (S)</p>	<p>Touche poussoirs Cadran (O.V.) Cadran (S)</p>	<p>Pulsador Cuadrante Cuadrante</p>	<p>P5 420 32/139/F.C. A3 939 87 A3 539 88</p>	<p>Pulsador Cuadrante Cuadrante</p>
<p>S1 } S1a } S2 } S5 } S4 } S5 } S6 } S7 } S8 } S9 }</p>	<p>510 } 511 } 512 } 513 } 514 } 515 } 516 } 517 } 518 }</p>	<p>S19 } S19a } S20 } S21 } C23 } S22 } S23 } S24 } S25 } S26 } C26 } C27 }</p>	<p>S27 } S28 } S29 } S30 } S31 } C33 } C34 } S32 } S33 } S34 }</p>	<p>A3 910 02 A3 129 50 A3 910 03 A3 162 06</p>	<p>918/08 49 001 98 909/24 910/B250 909/74</p>	<p>909/X16 909/W100 C 425 AL/B40 909/X16 E09B AL/OOR25 R21 } R27 } R35 }</p>
<p>To order parts which do not occur in this list consult the Catalogue for Service Spare Parts.</p>	<p>Voor het bestellen van onderdelen welke niet in bovenstaande lijst vermeld zijn, raadplege men de Catalogus voor Service Standaard Onderdelen.</p>	<p>Falls Ersatzteile welche nicht in der oberrstehenden Liste angegeben sind bestellt werden müssen bitten wir Sie, unser Service Standard Buch zu Rate zu ziehen.</p>	<p>Pour la commande des pièces qui ne figurent pas dans cette liste, veuillez consulter le Catalogue des Pièces de Réchange Standard.</p>	<p>Para las piezas que no figuran en las listas de piezas consultese el Catalogo de piezas de Re-cambio de Standard.</p>	<p>8</p>	<p>8</p>